

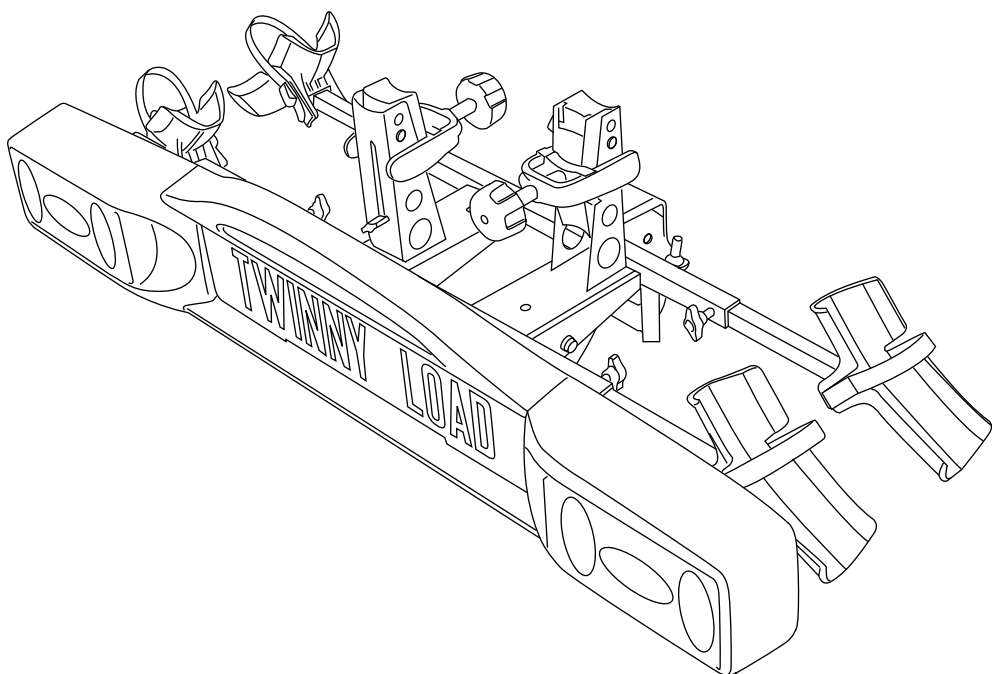

# Twinny Load<sup>®</sup> Traditional C Twinny Load<sup>®</sup> Prestige PS



**Montagevoorschrift en gebruiksaanwijzing**  
**Montage- und Gebrauchsanleitung**  
**Installation and use instructions**  
**Instructions de montage et mode d'emploi**

## Noteer voor uw eigen administratie:

### Type drager:

- Traditional C
- Traditional CK
- Swing CK
- Swing FK
- Ergo CK
- Ergo FE
- Quattro
- Off-Road
- .....

Serienummer: .....

Aankoopdatum: .....

## Bitte notieren Sie zur eigenen Erinnerung:

### Trägertyp:

- Prestige PS
- Prestige PA
- Compact PA
- Compact RP
- Prestige ECO
- Perfect ECO
- Quattro
- Off-Road
- .....

Serienummer: .....

Kaufdatum: .....

## For your own administration, write down the following:

### Carrier type:

- Traditional C
- Traditional CK
- Swing CK
- Swing FK
- Ergo CK
- Ergo FE
- Quattro
- Off-Road
- .....

Serial number: .....

Purchase date: .....

## Notez pour votre dossier:

### Type du porte-vélos:

- Traditional C
- Traditional CK
- Swing CK
- Swing FK
- Ergo CK
- Ergo FE
- Quattro
- Off-Road
- .....

Numéro de série: .....

Date d'achat: .....

Hartelijk gefeliciteerd met de aanschaf van uw nieuwe Twinny Load® fietsdrager. U kunt er nu zorgeloos met de auto en fietsen op uit trekken. Gewoon, lekker actief zijn en nieuwe routes verkennen. We wensen u veel plezier met uw nieuwe fietsdrager.

NL

Wir gratulieren Ihnen zum Kauf Ihres neuen Fahrradträgers von Twinny Load®. Sie können jetzt unbesorgt mit dem Auto und Ihren Fahrrädern losziehen. Zugleich sportlich aktiv sein und neue Wege erkunden. Wir wünschen Ihnen viel Spaß mit Ihrem neuen Fahrradträger.

D

Congratulations with the purchase of your new Twinny Load® bicycle carrier. You can now go touring carefree by car and bicycles. Simply staying active and discovering new routes. Good luck with your new bicycle carrier!

GB

Toutes nos félicitations pour l'achat de votre nouveau porte-vélos Twinny Load®. Vous pouvez ainsi partir en toute sérénité en balade avec votre voiture tout en emmenant chaque fois vos vélos avec vous. Une belle façon de rester actif et de découvrir de nouveaux itinéraires.  
Alors, Amusez-vous bien avec votre nouveau porte-vélo!

F

# General

## Ball pressure

The type plate of the towing hook indicates the maximum permissible ball pressure. The total combined weight of the bicycle carrier and bicycles may not be higher than this ball pressure and in no case may it be higher than 75 kg. The weight of the Twinny Load® Traditional C is 10.9 kg. You can find the weight of your bicycle in the supplied booklet or perhaps on the Internet.

## Lighting

The lighting of the bicycle carrier is 12V.

## Legal requirements

You will find the legal requirements that apply in Europe for the transport of bicycles on a bicycle carrier at [www.twinnylload.com](http://www.twinnylload.com)

## Quality

All carriers are designed and produced in accordance with the highest quality standard. Stability, flexibility, ease of use, good driving behaviour and solidity are of paramount importance for us.

## Cleaning

Clean the carrier after use and ensure that it is free from brine and diesel deposit.

## Storage

Store the carrier at all times in dry condition.

## Accessories

Various accessories are available for your bicycle carrier. For a complete overview go to [www.twinnylload.com](http://www.twinnylload.com) or obtain information at the sales address.

## Tools

To install and set up the bicycle carrier you need:

- 1 x 6mm allen key;
- 2 x open-ended / ring spanner 17mm.

# Components of Twinny Load® Traditional C

- 1 x carrier
- 4 x wheel rails
- 1 x guide set
- 1 x padlock
- 1 x 6 mm allen key
- 13/7-pole adapter (with 13-pole plug)
- guarantee card

## Warnings

- The bicycle carrier must be assembled according to the installation instructions.
- The carrier and bicycle must be installed according to the use instructions.
- No changes may be made to the product.
- The lighting is intended for a 12V installation.
- After the first kilometres, check the attachment of the bicycle carrier and bicycles.
- Adjust your speed at speed ramps.
- Never use straps or ropes to fasten your bicycle. These can irreparably damage the frame of your bicycle.
- In principle, an electrical bicycle fits on a Twinny Load bicycle carrier. This depends on the brand and type of electrical bicycle. You will find a fitting table on our website under the button "Manuals".
- Attention! When the fog rear light remains on constantly after connecting your bicycle carrier, the socket of the car is not connected in accordance with the DIN. Have this repaired by your garage.

### **Before driving, check that:**

- the bicycle carrier is well attached to the towing hook;
- the lighting on the bicycle carrier functions properly;
- the two light units are set at the correct width and are clicked into the securing device;
- no cable is hanging loose;
- all wing bolts of the wheel rails are tightened;
- the clamps on the pedal arm of the bicycles are well tightened;
- all wheels have been fixed with the straps;
- the lock of the tilting mechanism is in the hole and blocked;
- no loose items are on the bicycles or bicycle carrier;
- the keys are removed from the locks.
- the fog rear light is in the left light unit.

## Installation of number plate

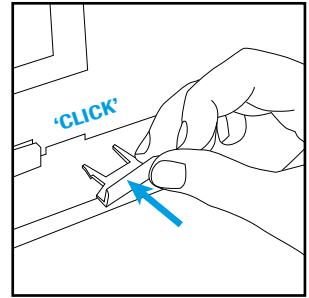
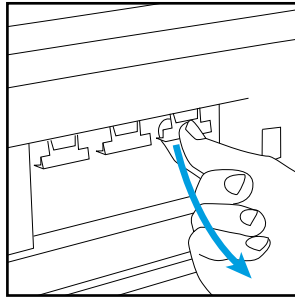
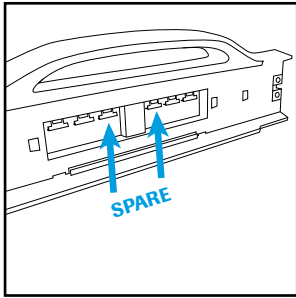

Break four lugs out of the light bar and place them in the cut-aways.

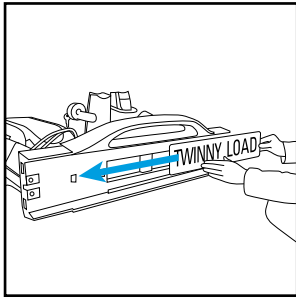

Beware!

Slide short Belgian number plate up to the first stop.  
Austrian number plate can be installed without lugs.

Slide the number plate into the light bar up to the second stop.

## Installation of wheel rails

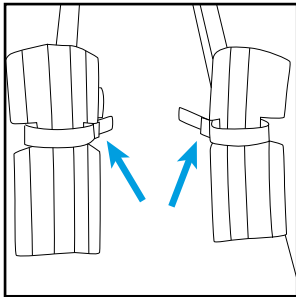

Install the four wheel rails with the clips inwards.

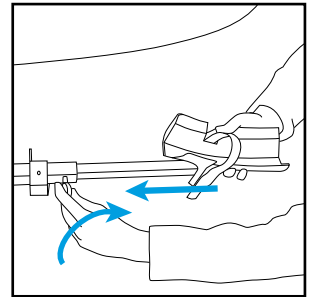
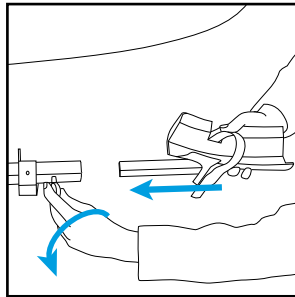

Pull on the wing bolt and loosen it until the rail fits into the tube.  
Slide in the wheel rail halfway and tighten the wing bolt.

## Installation of guide set and bicycle carrier

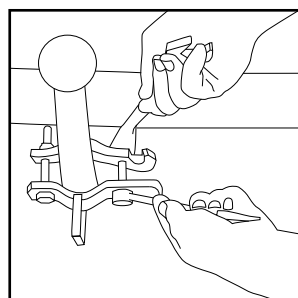
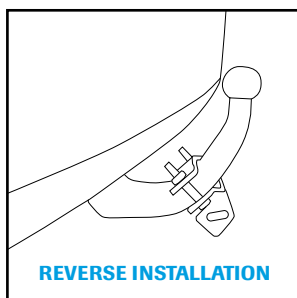
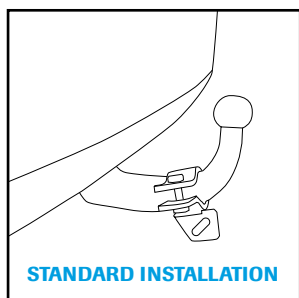

The guide set can be installed in two different ways. The standard installation method is the most common. If there is not enough space, the bend too long or the towing hook too high, the reverse installation method can be used.

Assemble the bracket to the towing hook and fix the bolts in such a way that the bracket can still slide across the towing hook.

GB

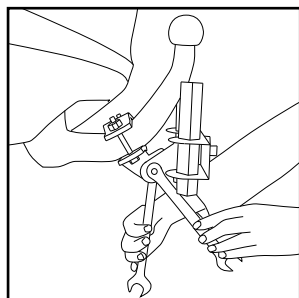

Install the guide set.

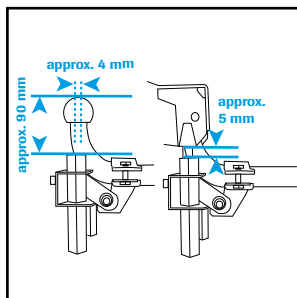

Adjust the guide set in such a way that the pins of the bicycle carrier slide into the guide bushes. Adhere to the measurements mentioned above. Tighten all bolts well.

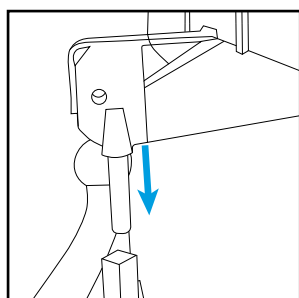
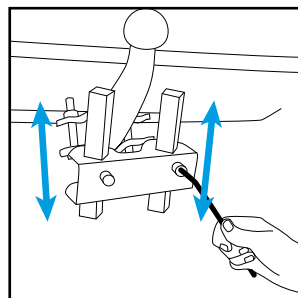

Place the bicycle carrier and tighten the T-bolt well.

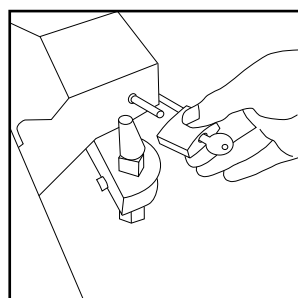
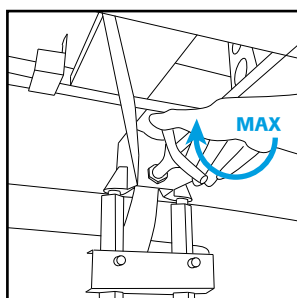

Lock the bicycle carrier.

## Installation of light units

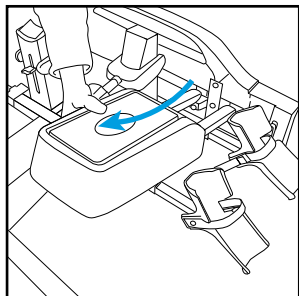

Take the light units out of the storage position and slide them into the guide of the light bar.

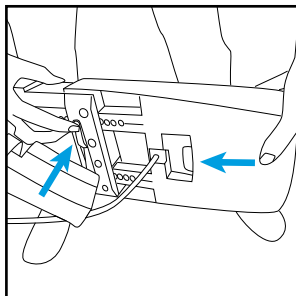

Place the light units in the light bar, press the red unlocking device and slide them inside.

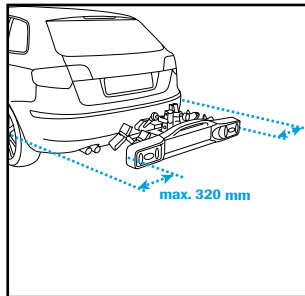

Width adjustment: press the red unlocking device and slide the light units out in steps of 1 cm.

### Car width

Up to 1,80 m  
Up to 1,84 m  
Up to 1,88 m  
Up to 1,92 m  
Up to 1,96 m  
Up to 2,02 m

### Slide out per side

do not slide out  
2<sup>nd</sup> click  
4<sup>th</sup> click  
6<sup>th</sup> click  
8<sup>th</sup> click  
11<sup>th</sup> click (= max)

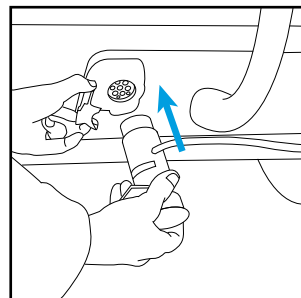

The width of your car is listed in the car's instruction manual.

Connect the plug and check the lighting.

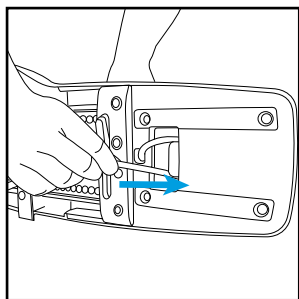

Put away superfluous wiring.

## Placing of bicycle

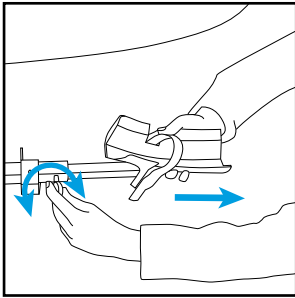

Slide out the wheel rails halfway and tighten them.

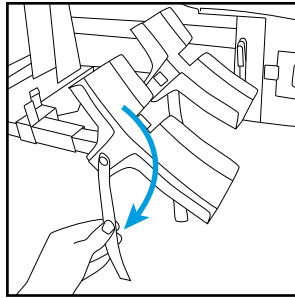

Loosen the straps and turn them downwards.

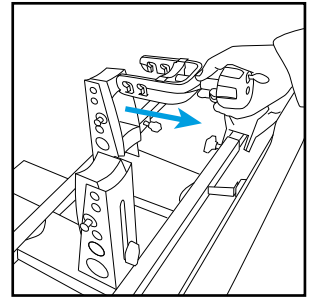

Remove the clamp from the holder.

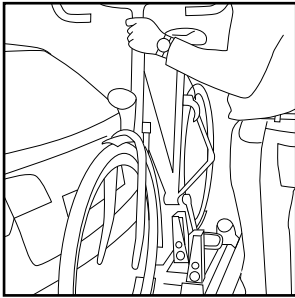

Place the first bicycle in the wheel rails closest to the car with the handlebars to the left and the pedal downwards.

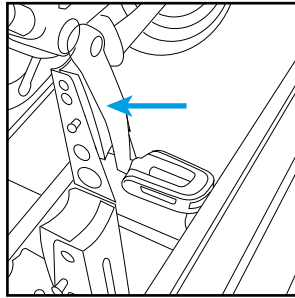

Position the pedal arm in front of the holder. Hook the clamp over the projecting steel lugs. Do not yet tighten it.

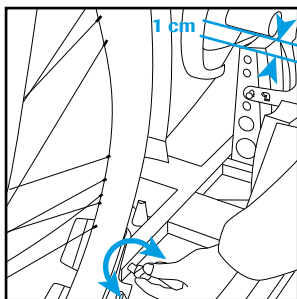
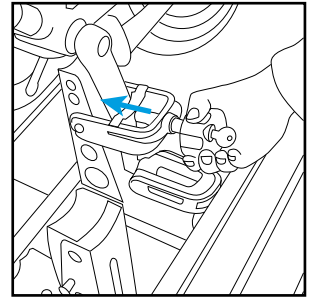

Adjust the wheel rails in such a way that the bicycle floats approximately 1 cm above the holder. Slide out = bicycle up; slide in = bicycle down.

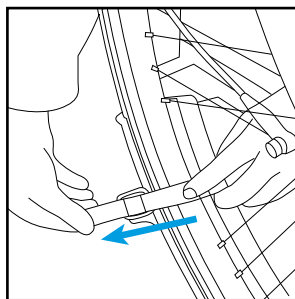

Fasten the straps.

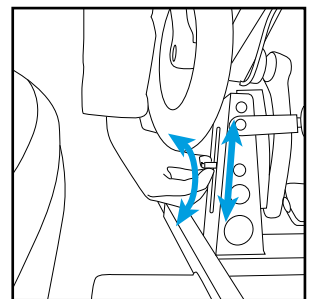

Adjust the holder in such a way that it rests against the pedal arm and the bicycle is upright.

## Cont. placing of bicycle

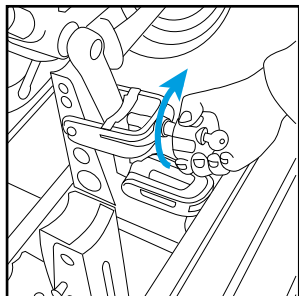

Tighten the clamp.

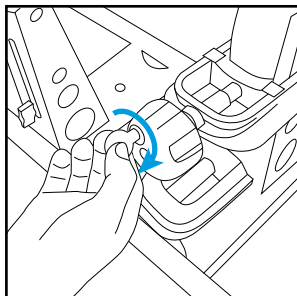

Lock the clamp.

Place the second bicycle with the handlebars to the right and the left pedal downwards.

## Extra setting

**The bicycles touch each other. The bicycle touches the lid of the boot.**

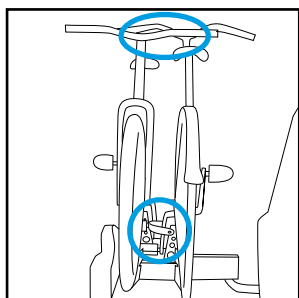

The bicycle touches the lid of the boot: adjust the holder in such way that the bicycle doesn't touch the lid of the boot.

The bicycles touch each other: adjust the holders in such way that both bicycles stand obliquely outwards.

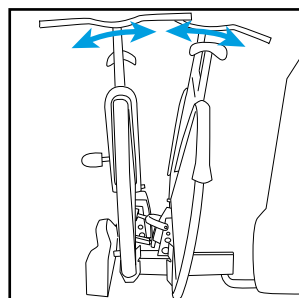
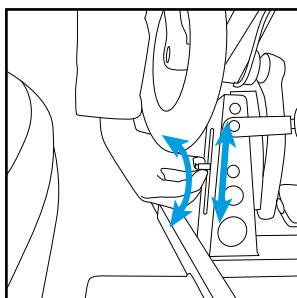

**The handlebars touch the saddle of the other bicycle.**

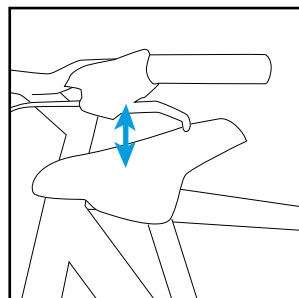
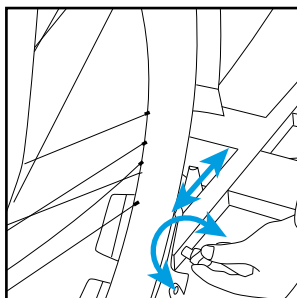
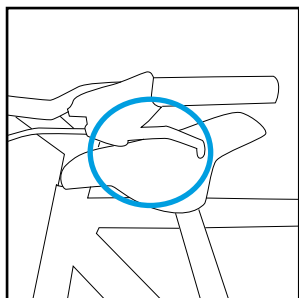

By adjusting the wheel rails in front and back a few cm, the bicycles will tilt slightly and no longer touch each other.

**The pedal arm is too high, the clamp does not fit, the bicycle stand is in the way.**

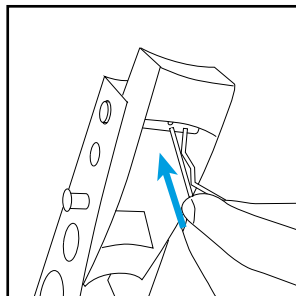
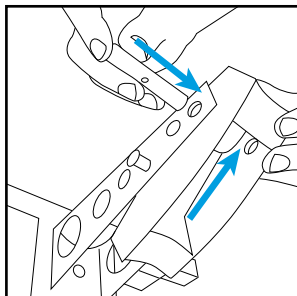
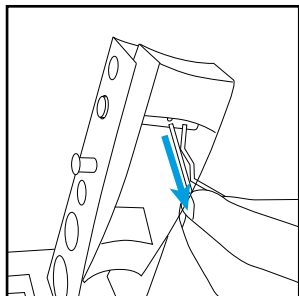

Install the holder one position higher by pulling the securing clip out of the axle and then installing the axle and support in the higher position and apply the securing clip again.

## Storage of light unit

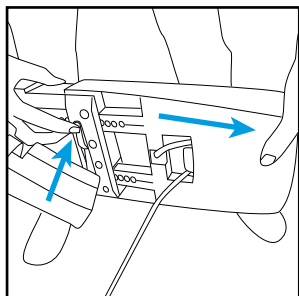

Push in the red unlocking device and slide the light unit out of the light bar.

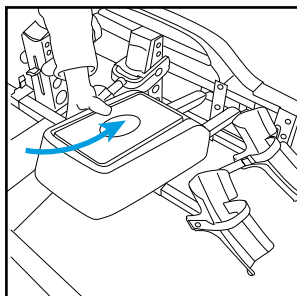

Position the projecting guides of the light unit in the back of the light bar.

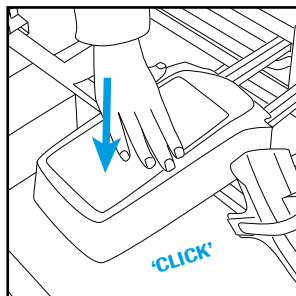

Push the light unit down into the clamp.

# Guarantee

On presentation of the guarantee certificate and purchase ticket, Felua-groep gives a seven-year guarantee on the Twinny Load® bicycle carrier, counting from the date of purchase as listed on the purchase ticket.

The guarantee consists of free repair or replacement of parts in case of material and construction errors.

The guarantee is effective after you have activated the guarantee certificate on the Twinny Load website [www.twinnyload.com](http://www.twinnyload.com) or via sending the reply card supplied with the guarantee certificate.

## **Terms and conditions:**

- The bicycle carrier must be assembled according to the supplied installation instructions.
- The bicycle carrier must be installed on the car according to the supplied use instructions.
- The bicycles must be placed and fixed on the bicycle carrier according to the supplied use instructions.
- No changes may be made to the product.
- Any responsibility for personal injury and/or damage to properties and ensuing asset loss that are caused by improper installation or improper use shall be excluded.
- There shall be no guarantee on defects that are caused by accidents, illegal and incompetent use of the vehicle or defects of the vehicle on which the bicycle carrier is installed.
- The term of guarantee shall not be extended or renewed due to performance of guarantee activities.
- Repair or replacement of the product within the specified term of guarantee shall only be possible for the original buyer in accordance with the purchase certificate.
- Claims should be submitted at the purchasing address listed on the purchase ticket. The bicycle carrier, including all supplied components, must be left behind at this address.
- The buyer is responsible for the costs of returning and collecting the product and/or parts at the purchasing address.
- The guarantee shall be cancelled if the bicycle carrier has been handled carelessly and improperly or poorly maintained, such at the discretion of Felua-groep.
- The guarantee shall be cancelled if the serial number has been changed, damaged or removed. The bicycle carrier must meet the technical specifications.
- The guarantee shall be cancelled if there is no purchase ticket, the ticket has been changed or is illegible.
- Defects as a result of wear due to normal use, such at the discretion of Felua-groep, shall not fall under the guarantee.

## **Disclaimer**

The guarantee does not cover materials not installed by Felua-groep. The manufacturer's liability pursuant to the agreement is expressly limited to compliance with the guarantee obligations described in this certificate. Any claim for damages, except those in respect of non-compliance with guarantee obligations, is excluded. Taking into account the mandatory provisions of law concerning (product) liability, more rights can never be derived with respect to any business or consequential loss, or (personal) loss of whatever nature, ensuing from defects to the materials or activities delivered by Felua-groep.

